

Important Notice for Servicing Monitors

● General Notice :

This service manual is prepared to assist service organizations or engineers who are in charge of servicing monitors in the field. This manual, therefore, is not for end users but for those technically oriented service engineers from distributors, dealers, VARs and other wholesalers or retailers who are capable of servicing the unit.

This manual explains the monitor's outline, detailed features, functions, basic construction of the individual unit and the circuits, sophisticated adjustments and detailed troubleshooting procedures for NANA O monitors.

Please read and understand this manual before attempting service.

This manual uses the following conventions.

DANGER

It indicates a potentially hazardous situation which, if not avoided, will result in death or serious injury.

WARNING

It indicates a potentially hazardous situation which, if not avoided, could result in death or serious injury.

CAUTION

It indicates a potentially hazardous situation which, if not avoided, may result in minor or moderate injury and/or property-damage.



It indicates a prohibited action.



It indicates a general caution.



It indicates a caution which, if not avoided, may result in electric shock.

 DANGER

- 1) **The monitor contains high voltage circuit. Only experienced service personnel should perform repairs or service work on high voltage monitors.**

When the cabinet of the monitor is removed and the monitor is operating, there is a risk of an electric shock hazard.



- 2) **When designing and manufacturing the equipment or the product by using the monitor, realize the monitor feature and consider the safety.**



- 3) **Never modify any part of the equipment without permission by authorized party.**

NANA O corporation will not be responsible for any damage or incident caused by an unauthorized modification.

 WARNING

- 1) **Unplug the power cord before servicing.**

Ensure the power cord is disconnected before replacing any parts in the unit. There is a risk of the electric shock hazard or damage.



- 2) **Do not wear any metal or accessories.**

There is a risk of an electric shock.

●Precautions for Servicing :

1. General

WARNING



- 1) **Do not connect or disconnect any wires or connectors while the monitor is in operation.**

It may result in damage to the circuit or may cause an electric shock.



- 2) **Do not short any portion of any circuit while the monitor is in operation.**

This will cause smoke, electric shock or damage to the transistors, ICs or other parts or circuit in the unit. (*Excluding the Adjustments only when specified.)



- 3) **Do not change the original design of the monitor.**

This will cause smoke, electric shock or damage to the circuit.

- 4) **Replace only with the exact factory recommended spare parts.**

The use of unauthorized substitute parts may cause an electric shock, damage to the monitor, or may exceed the specified X-ray radiation.

- Safety related parts Parts List : "S" Circuit Diagram : ""
 - X-ray related parts Parts List : "X" Circuit Diagram : "★"
 - Anti-static related parts Parts List : "A"
 - Moisture protection related parts Parts List : "M"
-

CAUTION



- 1) **Do not touch the sharp edge of the chassis.**

It may result in injury.

2. Precautions for Servicing CRT

⚠ WARNING

- 1) **Disconnect the Power Cord, and completely remove static charge before taking off the Anode Cap.**

When discharging high voltage, be sure to disconnect the power cord.

Connect a 10kΩ resistor (1W and over) and a insulator wire(such as a test probe) between CRT dag and the Anode Button.

If the High Voltage is not removed, you will get an electric shock by touching the Anode Cap area.

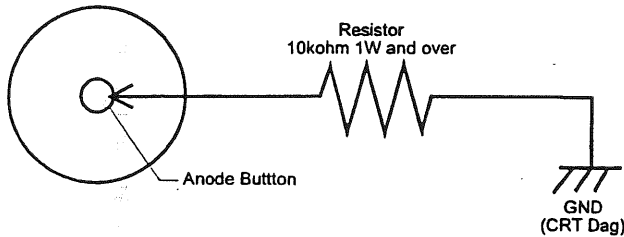
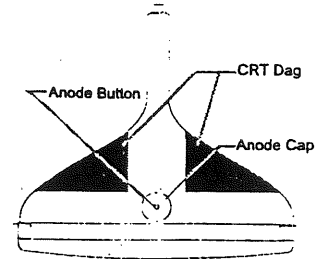

- 2) **Replace with a CRT of the same type number for continued safety.**

The CRT used in this monitor employs integral implosion protection.

If the CRT is replaced with a different type, it will result in an improper circuit function, exceed the specified Safety Standards range, or affect the picture quality guaranteed in the specifications.

- 3) **Use only CRT and PCB cording the same serial number.**

Apply silicon grease around anode button when putting anode cap on. Please make sure that only other material is not attached around contact area.

- 4) **Pay your attention to CRT neck and PCB-CRT. Do not touch them to the other material.**

This will cause the damage.

- 5) **Follow the instructions below when mounting the Anode cap.**

Surely mount the Anode cap and paint the silicone grease. High voltage may leak from the Anode cap and there is a risk of electric shock and damage.

- (1) Clean up around the Anode button and inside of the Anode cap.
- (2) Paint the Silicone grease equally around the Anode cap with a paint-brush.
(Recommended grease; KS-650N, Shinetsukagaku)

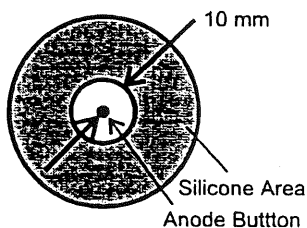

Do not paint inside of 10mm.

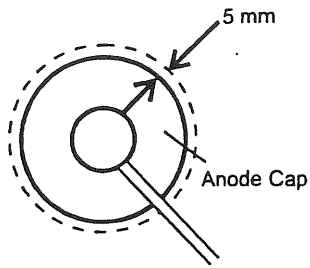

Over-painted area may be less than 5mm.

- (3) Lock the hook inside of the Anode cap onto the Anode button and attach the X-ray protection metal onto the Anode button surely.

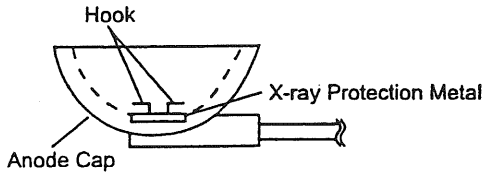

- (4) Confirm that the Anode cap is completely stuck on the surface and any partial tearing or lifting of it should not be recognized.
- (5) Confirm that the Silicone grease is painted 5mm beyond the Anode cap brim.
-
-

 CAUTION



1) **Do not lift the CRT by the neck.**

The neck of the CRT is not firm enough to hold the entire CRT. Hold the CRT under your arms when lifting it. In case the CRT is dropped, it could result in injury.

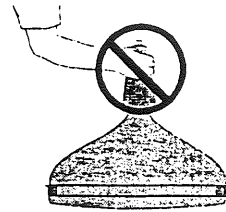

2) **Be careful about the followings to keep the special coating for anti-static and good contrast.**

- (1) Do not absorb the CRT surface with a vacuum absorption machine. It may damage the coating of the surface.
 - (2) Use a soft cloth to remove dust from the screen. If necessary, stubborn stains can be removed by moistening part of a cloth with water or alcohol (ethanol, methanol, or isopropyl alcohol) to enhance its cleaning power.
Never use cleaners including abrasives or bleach.
 - (3) Do not scratch or press on the surface with any sharp objects, such as pencil or pen as this may result in damage to the CRT.
 - (4) When carrying the monitor, do not scratch or press on the surface with any sharp objects, such as pencil or pen as this may result in damage to the CRT.
 - (5) Do not paste any seals on the screen. It may make some marks because of the ultra violet rays.
 - (6) Never remove four aluminum foil tapes each corners of the screen. It may result in decrease the anti-static effect.
 - (7) Do not give any impact to the CRT. If you give the impact to the CRT when using the monitor on face top style, there are more internal sparks of CRT than TV style. The internal spark is caused by the coating inside of the CRT that comes off and drops to the guns. Therefore, the impact to the CRT on face top style causes frequent internal sparks and improper Cut Off adjustment of the CRT that makes the screen invisible and loses the white balance. Also, the screen disappears for a moment when the spark occurs.
-

3. Electrical Circuit

WARNING



- 1) **Do not touch the +B Voltage and High Voltage terminals inside the monitor.**

The circuits of the monitor is divided into the Primary part and Secondary part which both are insulated. Do not touch the Primary or the Primary and the Secondary at the same time. And do not short both parts. If carelessly contacted, it can cause serious shock or result in damage to the monitor.

When adjusting, use some dielectric tools and do not touch any other volumes than adjustment ones.

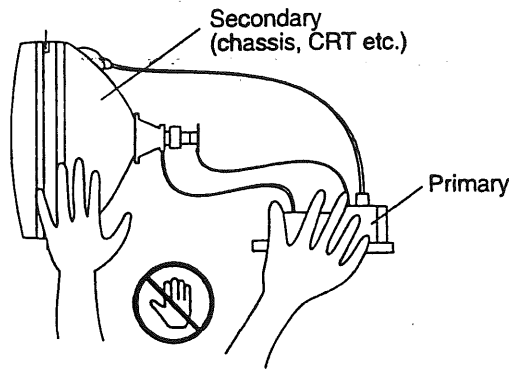

- 2) **Do not touch the inside of the monitor when operating. There is a part generating high voltage more than 20000V inside of the monitor.**

If necessarily, unplug the power cord before touching.

If an object such as solder or paper falls into the monitor, unplug it immediately. It can cause smoke, electric shock or damage to the circuit.

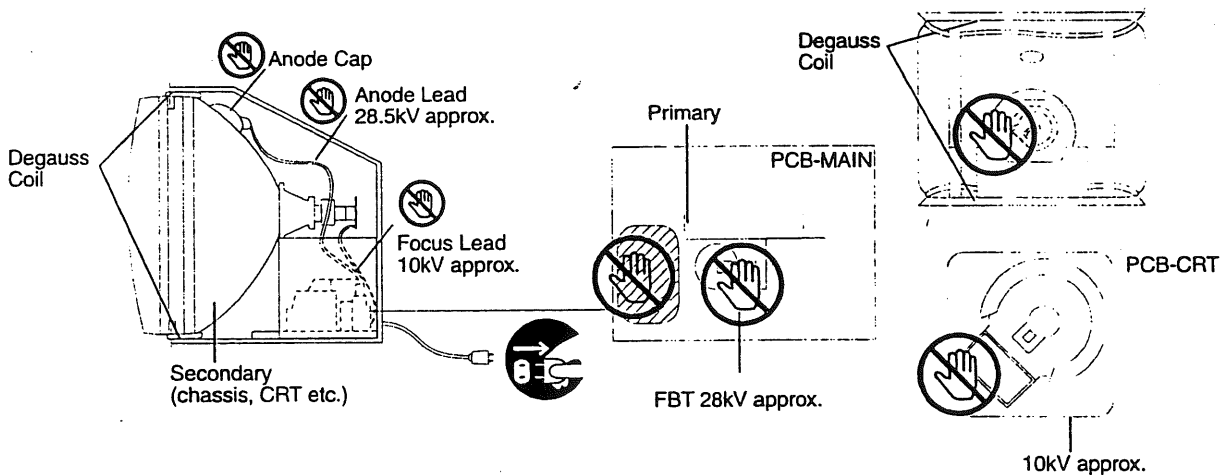



3) **Do not operate the monitor with a High Voltage level exceeding the specified range below.**

Failures in the High Voltage Adjustment can increase X-ray radiation. The maximum High Voltage range specified for operating the monitor is as below.

Specified Power Supply : 100~120V, 220~240V, Beam Current : zero

High Voltage level : 28.5 ± 0.6 kV

To check for the presence of High Voltage, use an accurate high impedance High Voltage Meter connected between the Anode Button and the CRT dag.

It may cause a rise in the voltage when the Power Supply Voltage is out of the specifications range.



4) **Do not clamp the high voltage lead (the red lead from FBT) with any other leads.**

The high voltage or static electricity .may cause an electric shock or damage to the circuit.

5) **Connect the coating earth to the PCB-CRT.**

Otherwise, it may cause an electric shock.

6) **Use 2 pin power plug of the Digital voltage meter.**

Otherwise, an electric shock, damage to the circuit or breaker-down may occur.

7) **When checking wave on the primary voltage line, use the 2-pin power plug of oscilloscope. Do not connect GND on the primary circuit and GND on the secondary circuit (chassis).**

If not, this may cause electric shock, damage to the circuit or breaker-down.



8) **Do not check on the primary and secondary voltage line with same oscilloscope at the same time. If necessary, connect the Isolation Transformer for the power of monitor.**

This may cause an electric shock or damage to the circuit.

4. Others

WARNING



1) **Take care not to scratch the coating of the Degauss Coil.**

Degauss Coil circuit is on the primary voltage line. When the coating of the Degauss Coil is damaged and the Coil directly touches the chassis or screws, the chassis voltage will become the same as the primary voltage line. This can result in hazardous danger as follows.

- (1) Electric Shock
- (2) Short (Current Leakage)
- (3) Degauss does not work
- (4) Circuit Damage
- (5) Damage of connected computers or peripherals. It can result in a hazardous fire or electric shock. Follow the instructions below.



2) **Do not bring any sharp objects such as the edge of the chassis close to the degauss coil, FBT, the anode lead and the focus lead.**

This may cause an electric shock or damage to the objects connected.

CAUTION

- 1) If you touch the CRT surface, you may feel a slight electric shock. This is caused by the static electricity being produced on the CRT surface and it does not affect the human body.
 - 2) When bringing one monitor close to another monitor, make sure the monitors' structure and setting. If one monitor has the different vertical frequency, another monitor image may flicker.
 - 3) If you shift horizontal position of the monitor until a part of the displayed image disappears, the image may be dark. This is not problem for monitor reliability. Readjust to gain the best position.
-

● Before Returning to the Owner :

To protect your customers, perform the following safety checks before returning the monitor.

A. Observance

WARNING

- 1) **Testing equipment should be isolated by putting an insulating board in between.**

When the back cabinet of the monitor is removed and the monitor is operating, there is a risk of an electric shock.

- 2) **Keep people away during the test.**

When the back cabinet of the monitor is removed and the monitor is operating, there is a risk of an electric shock.



- 3) **Do not wear any metal or accessories.**

There is a risk of an electric shock when the circuit is shorted.

B. Test Procedure

DANGER

When any portion of the chassis is short-circuit caused by a leakage of primary voltage line, the conductive area may become high voltage which can result in an electric shock or other hazardous danger.

1) Withstanding Voltage Check

Impress AC voltage between a conductive chassis and the line of the AC cord for 1~2 seconds when the Main Power Switch is ON. The buzzer of the testing equipment should not be NG.

100~120V: 1200 VAC (Electric current sensitivity: 5mA)

C. Safety Checks

- 1) Check and see that all the connectors are tightly inserted.
 - 2) Check and see that all the harness wires have been clamped as specified.
 - 3) Check and see that any lead wires are not caught between the chassis and other metal parts in the monitor.
 - 4) Check and see if the following important works for safety are surely performed.
 - The VR951 (+B ADJ) is surely locked with the silicone rubber after adjusting.
 - The Anode Cap and the Anode Rings are surely equipped.
 - The Anode Rings are equipped so that there should be more than 10 mm space between the Anode Lead and other parts.
 - The Coating Earth Lead is equipped with winding solder.
 - The Fuse (F901) is surely equipped.
 - 5) Check and see if the following important indications for safety are surely indicated.
 - The Label-HV is surely indicated near the anode of FBT, the Focus and Screen Lead, the DY Lead and the anode of CRT.
 - The Name Plate is surely put on the chassis.
 - The Label-HV-Fuse, the Label-DHHS and the Label-PTB-2932 are surely indicated on the CRT or the chassis.
-

SECTION I : SPECIFICATIONS

1. CRT SPECIFICATIONS

Type	A68KJU96X
Size Angle	29 inch class 110° deflection
Trio Pitch	Horizontal: 0.8 mm (Center), 0.97 mm (Edges) Vertical: 0.64 mm
CRT Surface	Anti-Static Coating
Light Transmission	49.5 % approx.

1-1 Limitation of M.P.D.(Missing Phosphor Dots) for CRT

This limitation of M.P.D is applied to the effective screen (phosphor area). In the other screen area, limited are no other defects than scratches preventing the antistatic effective in aluminum foil taped area.

Width (mm)	Max. Length (mm)
less than 0.05	No limit
0.06~0.13	50
0.14~0.20	19
more than 0.21	-

1-2 CRT Dimension

A68KJU96X

Unit: mm

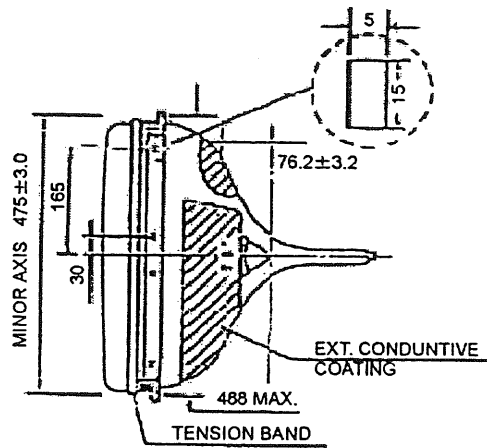
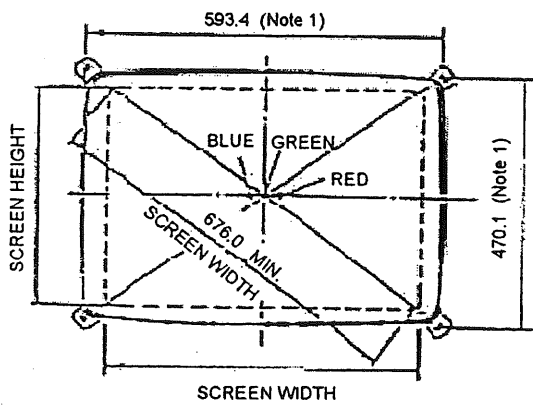
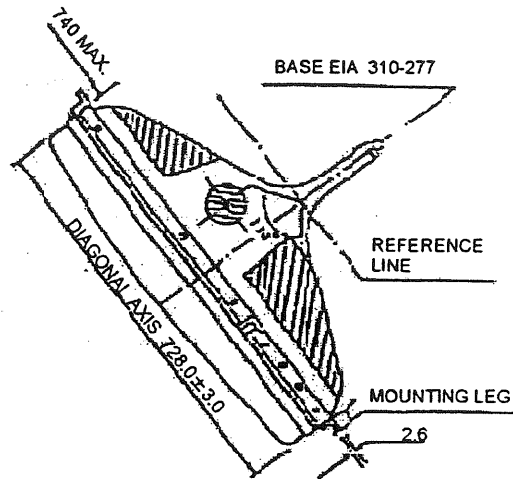
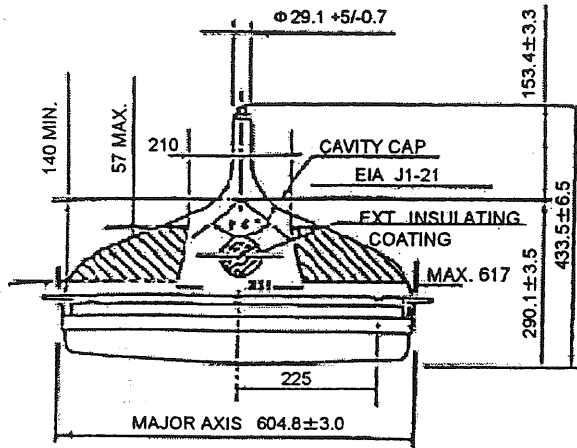

Curvature of the screen

Diagonal : R1580

Horizontal : R1660

Vertical : R1780

2. ELECTRICAL SPECIFICATIONS

All measurements are subject to the conditions listed in 5.1, unless otherwise specified by the item in section 5.2 to 5.4.

2.1 Standard measurement conditions

Input signal	Refer to 2.5 "Recommended signal timing chart".
Brightness	33% window pattern : 60 ft-L, white field pattern : 32 ft-L
Magnetic field	BH : 30 μ T, BV : 35 μ T
Measurement	After warm up for at least 30 minutes
Display area size	540 mm x 405 mm
Ambient temperature	Normal
Setting conditions	MS-2932-S/SW (TV style) The screen faces the east and the adjustment volumes and switches are in default settings, unless otherwise specified. MS-2932-SF/SFW (Facetop style) The screen faces the top, the CRT anode button faces the west and the adjustment volumes and switches are in default settings, unless otherwise specified.

2.2 Displaying Performance

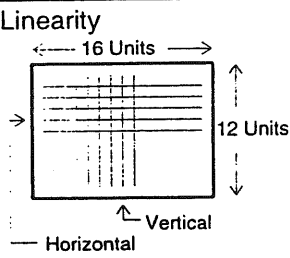
Items	Values	Conditions
Scanning Frequency	Horizontal: 31.50 \pm 500 kHz Vertical: 60 \pm 1 Hz	
Retrace Time	Horizontal: 6 μ s max. Vertical: 1.1 ms max.	
Linearity 	Horizontal: \pm 10 % max. Vertical: \pm 8 % max.	To be measured with Cross-hatch pattern As obtained through following formula. $H = \{(X \text{ max. or } X \text{ min.}) - (X \text{ Ave.})\} / (X \text{ Ave.}) \times 100$ $V = \{(Y \text{ max. or } Y \text{ min.}) - (Y \text{ Ave.})\} / (Y \text{ Ave.}) \times 100$
Center Resolution	640 x 633 dots	As obtained through following formula. Center Resolution = Display area size / Center phosphor pitch
Video Bandwidth	18 MHz min. (at -3dB)	Video output (standard) : 100kHz, 40Vp-p
Distortion		
(a) Trapezoidal	3.0 % max.	
(b) Barrel/Pincushion	3.0 % max.	
(c) Tilt	2° max.	To be measured based on JIS-C6101

ITC		
Jitters	To be invisible from the distance of 50 cm from CRT surface.	
Color Purity	Conspicuous different colors shall not be recognizable with Red-field pattern against all directions after the internal degaussing.	To be degaussed in each direction.
Convergence	<p>Max. deviation among RGB raster line center distances, either horizontal or vertical, shall not exceed the following:</p> <ul style="list-style-type: none"> • Within a circle whose diameter is equivalent to 60 % of V. length of CRT : 1.5 mm max. • Within a circle whose diameter is equivalent to vertical length of CRT (excluding the above circle): 2.5 mm max. • Within CRT screen (excluding the above circles) : 3.0 mm max. 	
White Balance	<p>x : 0.285 ± 0.02 y : 0.285 ± 0.02 Color Temperature 9700K approx.</p>	To be measured at center of a white-window pattern with Bright VR and Contrast VR in adjusted settings.
Focus	To be adjusted best.	
Maximum brightness	60 ± 10 ft-L	Input signal 0.7 Vp-p To be measured with a white field pattern.

2.3 Power Supply

Items	Values	Condition
Input current and voltage	100-120 VAC \pm 10 %, 50/60 Hz, 2 A (max.)	
In-rush current	72 A peak max.	At 132 VAC
Power Consumption	110 ± 16 W	To be measured in default settings with a white field pattern.
Leakage Current	<p>Less than 1.0 mA at 100 VAC 60Hz Less than 3.5 mA at 120 VAC 60Hz</p>	

2.4 Signal Input

Sync Input Signal Form	(a) H/V Separate, Positive/Negative (b) H/V Composite, Negative
Video Input Signal Form	Analogue, Positive
Scanning	Non-Interlace

2.5 Recommended Signal Timing Chart

31.50kHz

<Horizontal>

Unit : sec

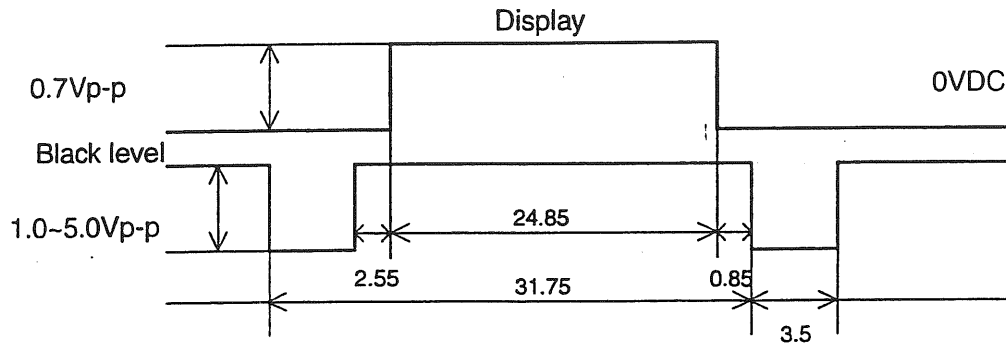

<Vertical>

Unit : msec

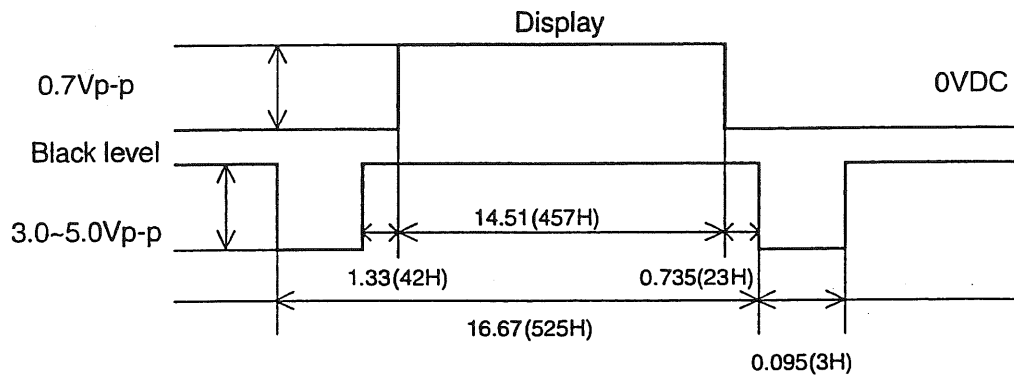

2.6 Adjustment Specifications

2.6.1 NAOMI (31k) Timing Chart

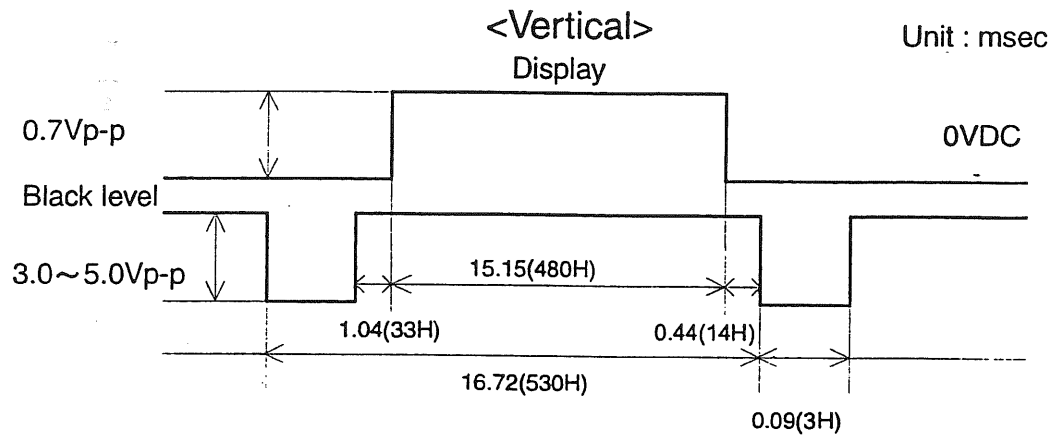
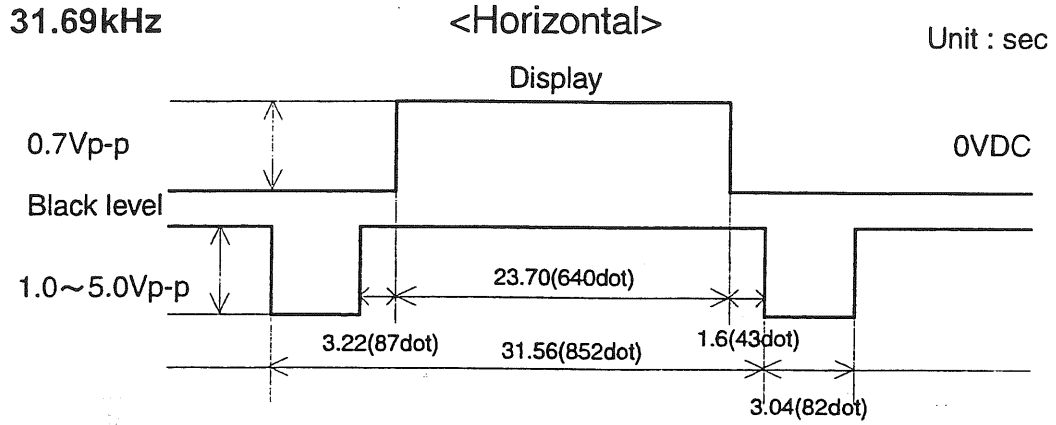

(MS-2932-S/SW)

1. Signal used for the adjustment

NAOMI (31k) supplied by Sega, or a signal equivalent to NAOMI

2. Adjustment Specifications

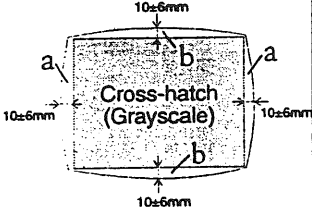
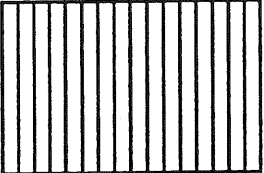

Items	Values	Conditions
<p>Display Area</p> 	<p>a. Horizontal edges : 10 ± 6 mm b. Vertical edges: 10 ± 6 mm</p>	<p>The screen shall face the east.</p>
<p>Scan Direction</p>	<p>The scanning shall start from left top corner when setting the anode button on the top.</p>	
<p>Display Position</p>	<p>To be centered.</p>	
<p>White Balance</p> <p>low ← → high</p>  <p>16 grayscale pattern</p>	<p>Conspicuous different white balance shall not be recognizable in low and high brightness part with 16 grayscale pattern. Low brightness level (1st gradation part) : 0</p>	<p>Brightness level is as follows; 2nd gradation part: 12/255 Other parts: $17 \times (n-1)/255$ $n=1\sim 16$</p>

(MS-2932-SF/SFW)

1. Signal used for the adjustment

NAOMI (31k) supplied by Sega, or a signal equivalent to NAOMI

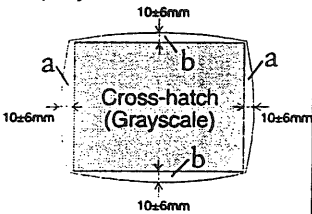
2. Adjustment Specifications

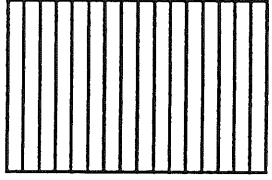
Items	Values	Conditions
<p>Display Area</p>  <p>Cross-hatch (Grayscale)</p>	<p>a. Horizontal edges : 10 ± 6 mm b. Vertical edges: 10 ± 6 mm</p>	<p>The screen shall set on the top. The anode button shall face the west.</p>
<p>Scan Direction</p> 	<p>The scanning shall start from right top corner when setting the anode button on the top.</p>	
<p>Display Position</p>	<p>To be centered.</p>	
<p>White Balance</p> <p>low ← → high</p>  <p>16 grayscale pattern</p>	<p>Conspicuous different white balance shall not be recognizable in low and high brightness part with 16 grayscale pattern. Low brightness level (1st gradation part) : 0</p>	<p>Brightness level is as follows; 2nd gradation part: $12 / 255$ Other parts: $17 \times (n-1) / 255$ $n=1-16$</p>

3. MECHANICAL SPECIFICATIONS

3.1 Adjustment Functions

3.1.1 PCB-VR The PCB-VR can be pull out 900 mm approx. from the monitor.

- Brightness Adjustment (BRIGHT)
- Contrast Adjustment (CONTRAST)
- Horizontal Size Adjustment (H.SIZE)
- Horizontal Position Adjustment (H.POSI)
- Vertical Size Adjustment (V.SIZE)
- Vertical Position Adjustment (V.POSI)
- Red Gain Adjustment (R-GAIN)
- Green Gain Adjustment (G-GAIN)
- Blue Gain Adjustment (B-GAIN)

3.1.2 PCB-MAIN

- Trapezoidal Distortion Adjustment (TRAP)
- Side Pincushion Distortion Adjustment (SPC)
- Vertical Linearity Adjustment (V.LIN)
- Parallelogrammic Distortion Adjustment (PARA)
- Blue Cut Off Adjustment (B.CUT OFF)
- Green Cut Off Adjustment (G.CUT OFF)
- Red Cut Off Adjustment (R.CUT OFF)
- Sub Contrast Adjustment (SUB.CONT)
- Focus Adjustment (FOCUS)
- Screen Adjustment (SCREEN)

Do not adjust above volumes except the authorized service personnel.

3.2 Power Cord

Power Cord specified for Sega

3.3 Configuration

NOTE: All of the dimensions, weights and angles below are reference values.

Dimensions (net)	625 mm (W) x 594 mm (H) x 481 mm (D)
Weight (net)	approx. 37.0 kg
Outline drawing	Refer to the below.

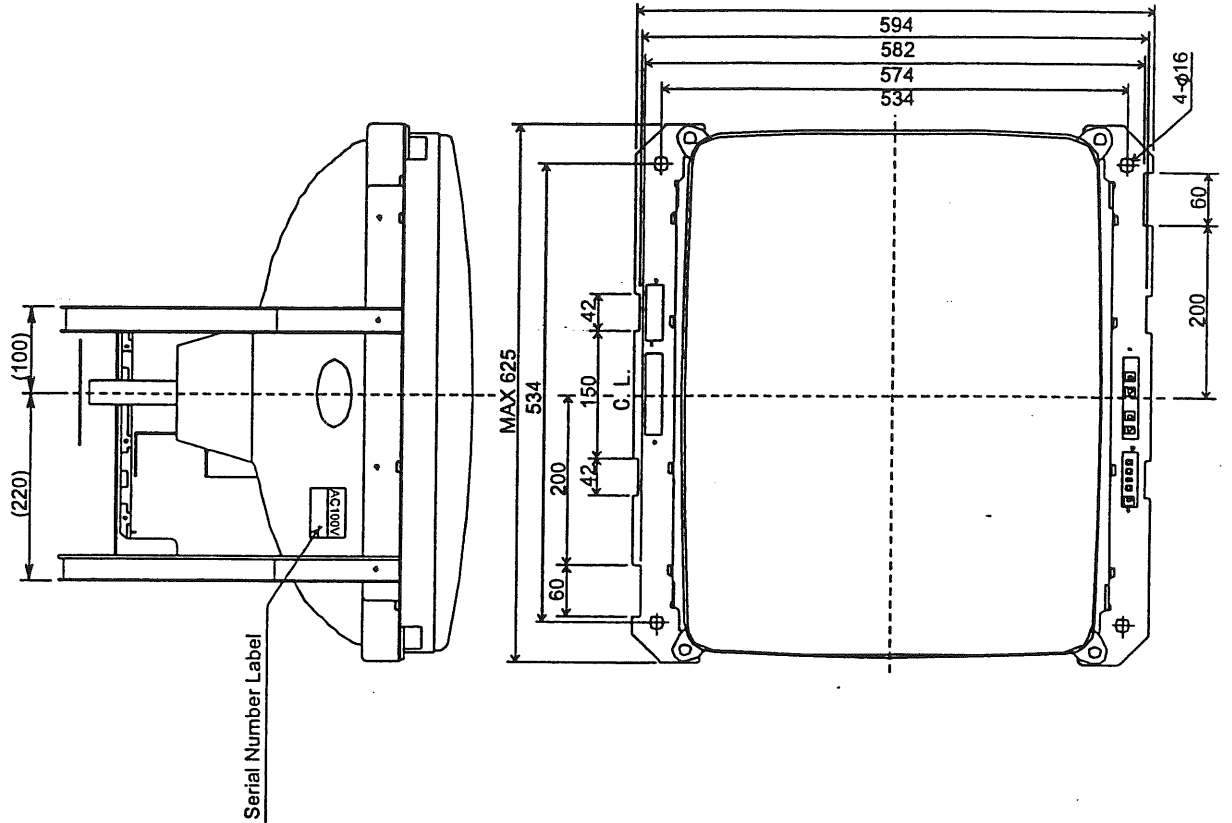

OUTLINE OF MONITOR
MS-2932
DIM IN mm
TOLE. ±3

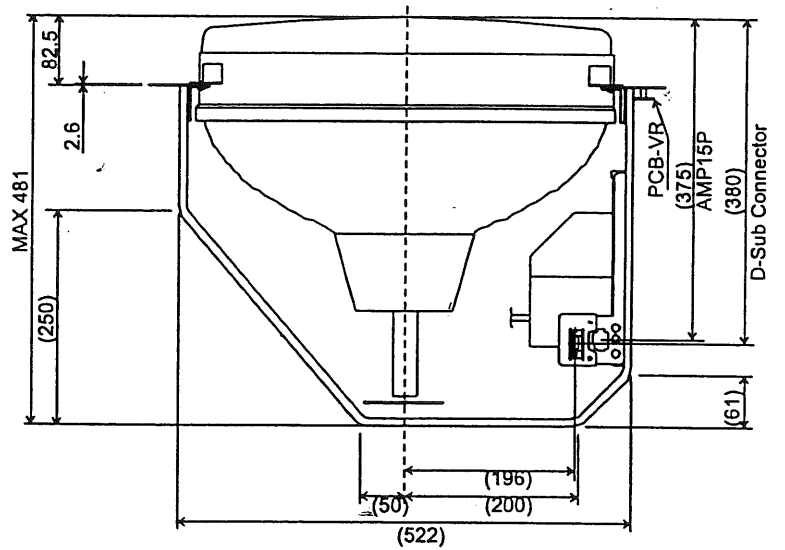

3.4 Packing specifications (unit package)

NOTE: All of the dimensions and weight below are reference values.

Packing dimensions	801 mm (W) x 597 mm (H) x 736 mm (D)
Packing weight	approx. 42.0 kg
Stack limit	3 units (Maximum)
Packing drawing	Refer to page I-17.

3.5 Packing specifications (pallet package)

NOTE: All of the dimensions and weight below are reference values.

Packing dimensions	1090 mm (W) x 850 mm (H) x 670 mm (D)
Packing weight	approx. 100.0 kg
Stack limit	2 units (Maximum)
Packing drawing	Refer to page I-18.

3.6 Connector Specifications

3.6.1 Connector Location

PCB-MAIN

<Top>

<Side>

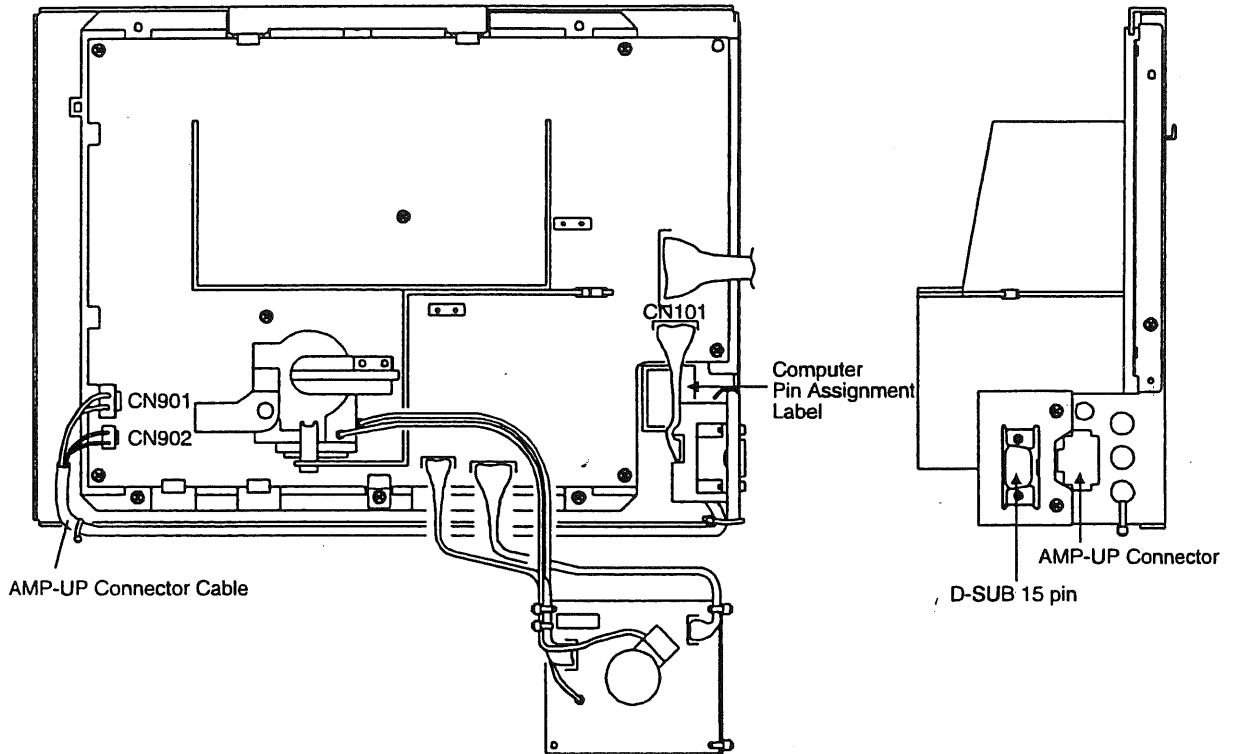

3.6.2 AMP UP Connector (176300-1)

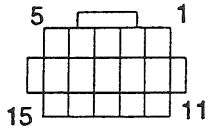

	Input Signal	Description
1		
2		
3		
4		
5		
6	AC Power Supply	100~120VAC ± 10%, 50/60 Hz
7	AC Power Supply	100~120VAC ± 10%, 50/60 Hz
8		
9	DEM	SW shall be connected between 9pin and 10 pin.
10	DEM	SW shall be connected between 9pin and 10 pin.
11		
12		
13		
14		
15		

Connector Pin Assignment Label

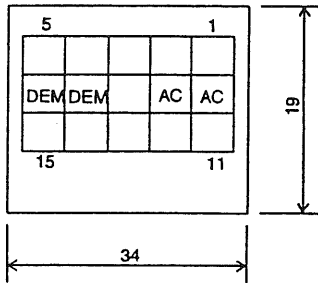

AMP UP Connector

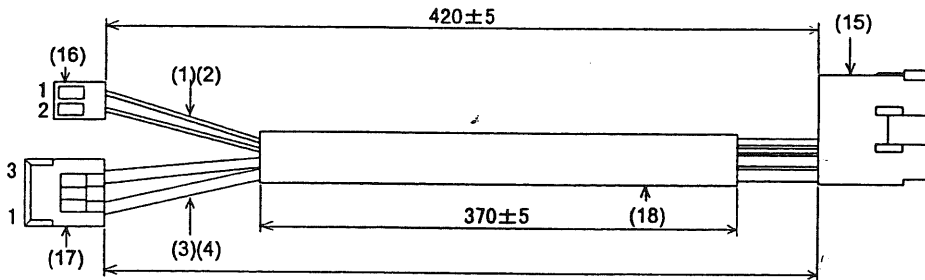

(15) UP Connector	(16) PHR-2 connecting to CN902
6 Black from (17) 1pin	1 Red from (15) 9pin
7 White from (17) 3pin	2 Red from (15) 10pin
9 Red from (16) 1pin	(17) VHR-3 connecting to CN901
10 Red from (16) 2pin	1 Black from (15) 6pin
1~5, 8, 11~15pin Open	3 White from (15) 7pin
	2pin Open

3.6.3 D-SUB 15 pin (mini) Connector

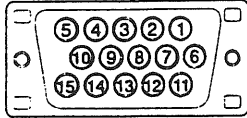

	Input Signal	Description
1	Red	Positive, 0.7Vp-p/75Ω
2	Green	Positive, 0.7Vp-p/75Ω
3	Blue	Positive, 0.7Vp-p/75Ω
4		
5	Ground	Ground
6	Red Ground	Ground
7	Green Ground	Ground
8	Blue Ground	Ground
9		
10	Ground	Ground
11		
12		
13	H.Sync or Composite Sync	Positive/Negative, Separate Sync, 3~5Vp-p Negative, Composite Sync, 1~5Vp-p
14	V.Sync	Positive/Negative, Separate Sync, 3~5Vp-p
15		

3.7 Conductive Aluminum Foil Tape Specifications

3.7.1 Name

TERAOKA 830

3.7.2 Dimension (reference values)

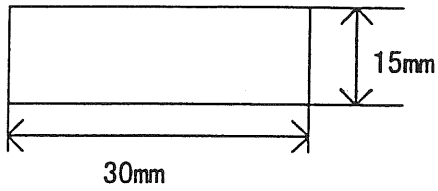

3.7.3 Taping

The aluminum foil tapes are put on to keep the surface of the panel and the integral implosion protection metal band conductive as follows (Since no problem is found in the mechanical and electrical performance.);

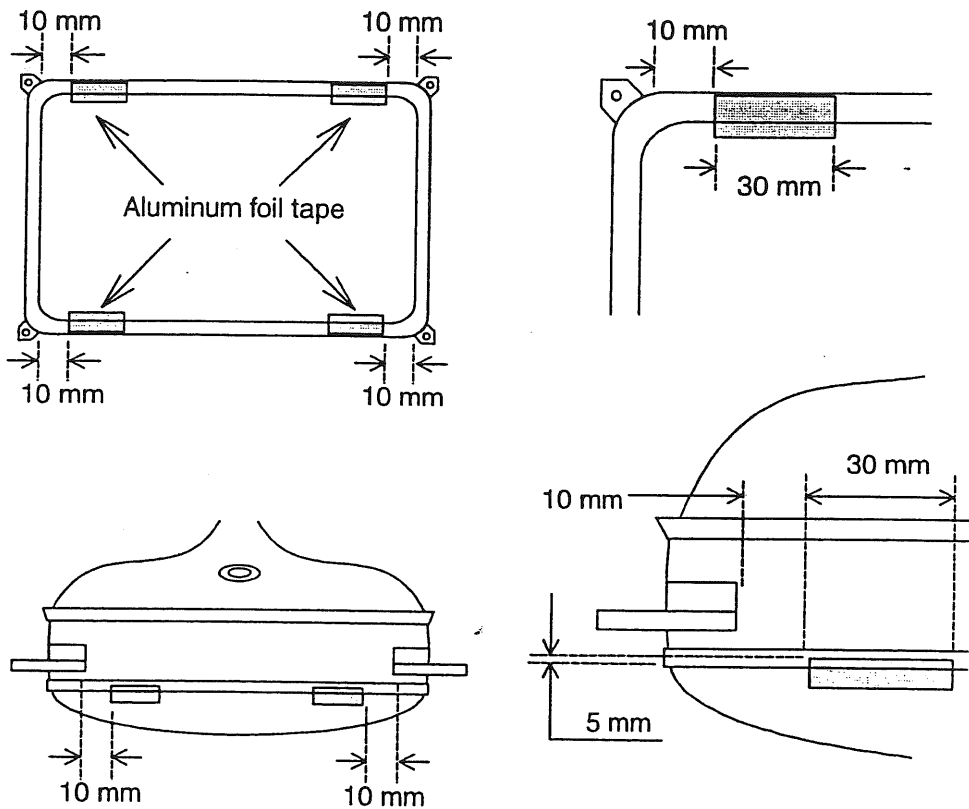

4. CERTIFICATIONS & STANDARDS

4.1 Certifications

Standard	Origin	Category				Marking
		Safety	EMC	Ergonomic	Other	
S-JQA	Based on Electrical Appliance & Material Control law (The 3 rd clause, Table No.8 "applied apparatus")	√				Name plate
TÜV	EN60950: 1991+A1+A2+A3+A4+A11	√				Name plate
CB	IEC60950: 1992+A1+A2+A3+A4	√				
UL	UL 1950 2 nd	√				Name plate
C-UL	CSA C22.2 No. 950 2 nd	√				Name plate
DHHS (DNHW)					√ (X-ray)	
PTB*					√ (X-ray)	

4.2 Standards (excluding Video components)

Standard	Category				Marking
	Safety	EMC	Ergonomic	Other	
VCCI Class A		√			
FCC Class A		√			

INSTALLATION INSTRUCTION FOR SAFETY REQUIREMENT

The monitor should be installed in following condition in order to meet the requirement of safety standard EN60950: 1992+A1+A2+A3+A4+A11

1. Power Supply

- a) The transformer which has double or reinforced insulation should be used between primary power source and the monitor.
- b) The rating of input power supply voltage should be 100-120Vac \pm 10%.

2. Ambient temperature

The ambient temperature around the monitor should be less than 40°C.

5. RELIABILITY & SAFETY

5.1 Reliability

MTBF	20,000 hours at standard power input excluding CRT. *Values calculated according to the simplified "Parts Count Reliability Prediction" method as specified in MIL- HDBK-217F.
AC line noise resistance	No synchronized condition shall be detected when applying 500Vp-p pulse by using a noise simulator.

5.2 Safety Aspect

Undesired radiation	Less than 0.1 mR/hour (1 μ Sv/H) at 10 cm distance.
High voltage label	To be pasted on the followings. <ul style="list-style-type: none"> • Top of the anode cap • The anode lead • The focus and screen lead • The DY lead

6. OPERATING ENVIRONMENT SPECIFICATIONS

Ambient Temperature		Operation: 0 °C~40 °C Storage : -20 °C~60 °C (The inner temperature of the amusement machine should be designed below 40°C.)
Ambient Humidity		Operation: 30 %~80 % R.H. Non condensing Storage: 30 %~80 % R.H. Non condensing
Altitude		Operation: up to 3,000 m Shipping or Storage: up to 12,000 m
Vibration	(Ass'y chassis unit)	To be free from any damage to the circuits nor the appearance on 1 hour 1 G vibration test to be carried out under 5~100~5 Hz varying frequencies in every 10 minutes. To be validated along all three axes.
	(Face-up)	To be free from any damage to the CRT on 1 hour 0.5 G vibration test to be carried out under 5~100~5 Hz varying frequencies in every 10 minutes. To be validated along the axes of the CRT.
	(Unit package)	To be free from any damage on 30 minutes 1 G vibration test to be carried out under 5~100~5 Hz varying frequencies in every 10 minutes. To be validated along all three axes.
	(Pallet package)	To be free from any damage on 40 minutes (or 1 hour in up-down vibration only) 0.5 G vibration test to be carried out under 5~100~5 Hz varying frequencies in every 10 minutes. To be validated along all three axes.
Drop Test	(Unit package)	To be free from any damage on free drop from 40 cm height once.
	(Pallet package)	To be free from any damage on free drop from 15 cm height and on drop with support (10 cm) from 15 cm height once.

7. PACKAGING SPECIFICATIONS

7.1 Unit package

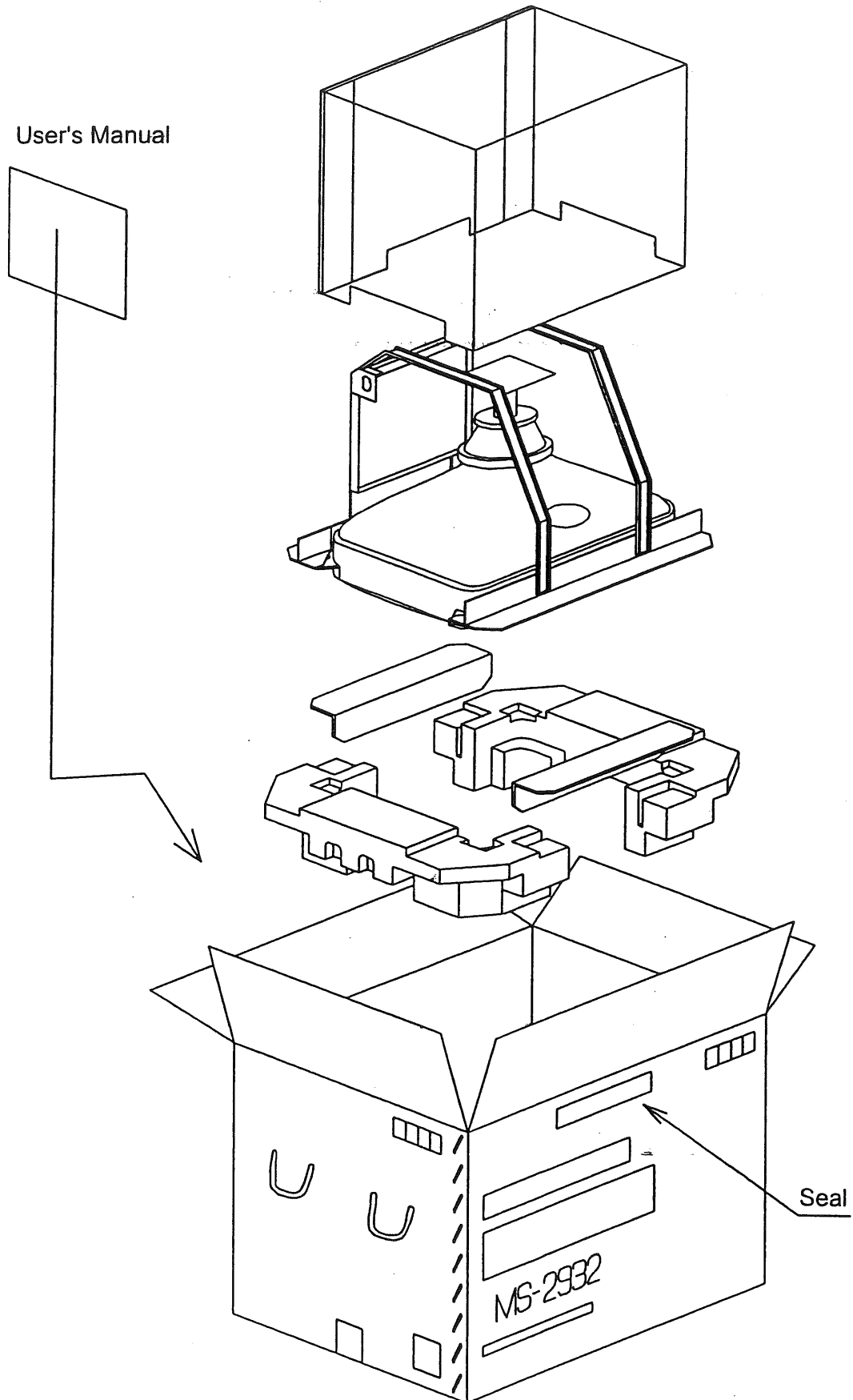

7.2 Pallet package

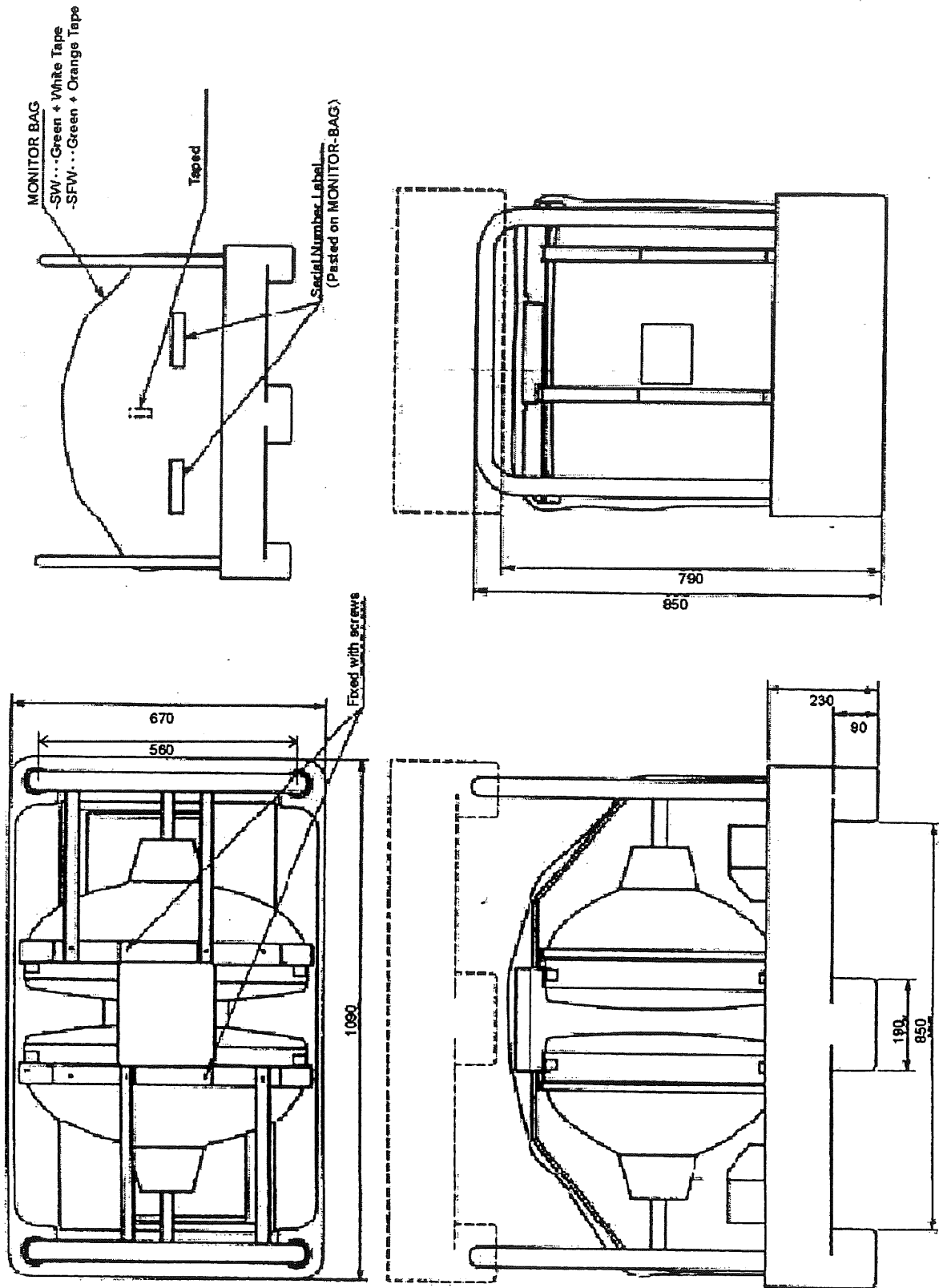

Pallet package layout

The PALLET SUPPORTs and the SUPPORT-29S should be placed on the PALLET as below.

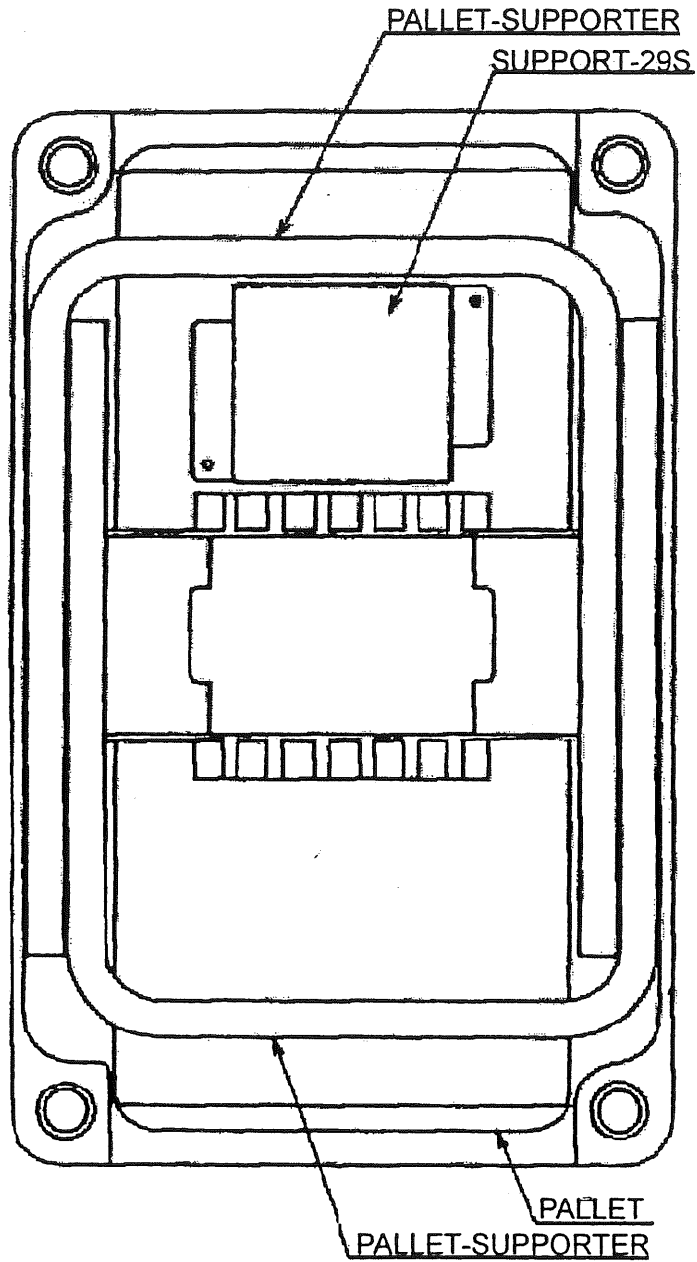

SECTION III : ADJUSTMENT CONTROL

Do not touch any other volumes than the below volumes if not necessary.

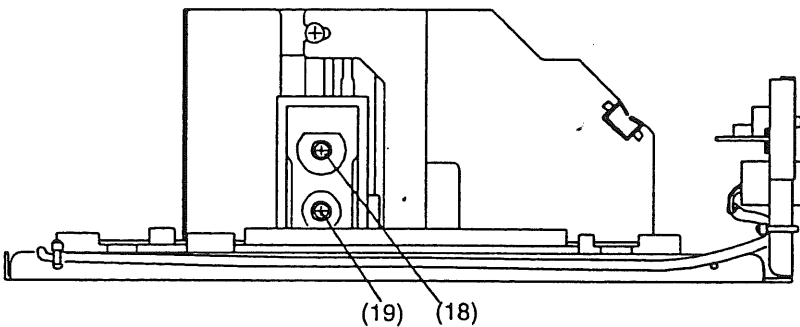
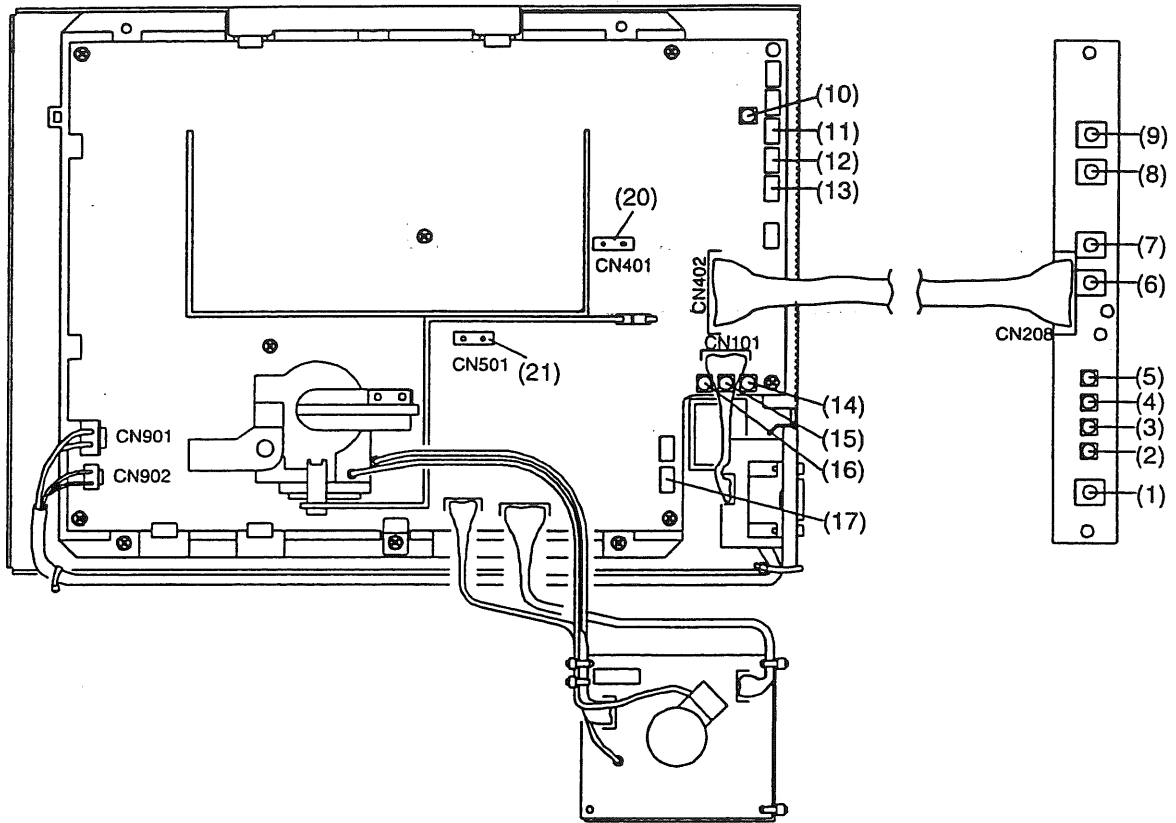

- (1) CONTRAST (VR283)
Screen contrast adjustment
- (2) R-GAIN (VR280)
RED INPUT GAIN adjustment
RED color gets deeper when turning this VR to clockwise.
- (3) G-GAIN (VR281)
GREEN INPUT GAIN adjustment
GREEN color gets deeper when turning this VR to clockwise.

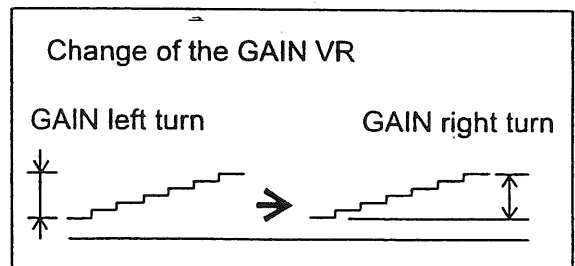

(4) B-GAIN (VR282)
BLUE INPUT GAIN adjustment
BLUE color gets deeper when turning this VR to clockwise.

(5) BRIGHT (VR284)
Screen brightness adjustment

(6) H. SIZE (VR285)
Horizontal size adjustment

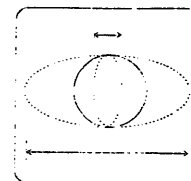

(7) H. POSI (VR286)
Horizontal phase adjustment

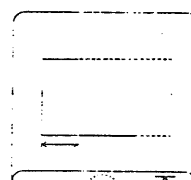

(8) V. SIZE (VR 287)
Vertical size adjustment

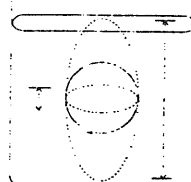

(9) V. POSITION (VR 288)
Vertical position adjustment

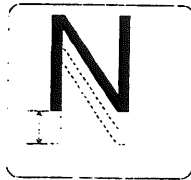

(10) V. LIN (VR401)
Vertical linearity adjustment

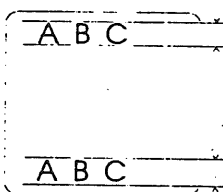

(11) TRAP (VR452)
Trapezoidal distortion adjustment

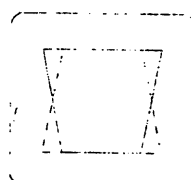

(12) SPC 15 (VR450)
Side Pin Cushion adjustment

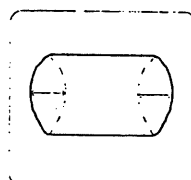

(13) PARA (VR552)
Parallelogrammic Distortion Adjustment

(14) B-Cutoff (VR 203)

BLUE BIAS adjustment
 BLUE color gets stronger when turning this VR to clockwise.

(15) G-Cutoff (VR202)

GREEN BIAS adjustment
 GREEN color gets stronger when turning this VR to clockwise.

(16) R-Cutoff (VR201)

RED BIAS adjustment
 RED color gets stronger when tuning this VR to clockwise.

(17) SUB.CONT (VR204)

Only if sufficient contrast is obtained with VR283, the screen contrast is adjusted with SUB.CONTRAST.





(18) Focus (VR on the FBT)

Adjust to get the best focus.

(19) Screen (VR on the FBT)

Adjust to just back raster disappearing.

(20) (21) Deflection Yoke Polarity Connectors

	CN401 normal	CN401 reverse
CN501 normal connection	 Normal screen	 Mirrored screen
CN501 reverse connection	 Reversed screen	 180° rotated screen

(20) CN401

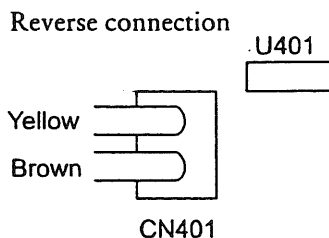
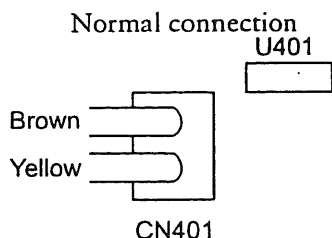

(21) CN501

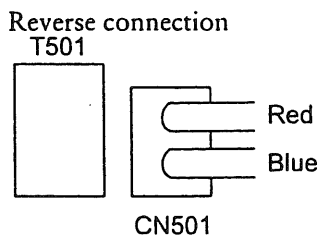
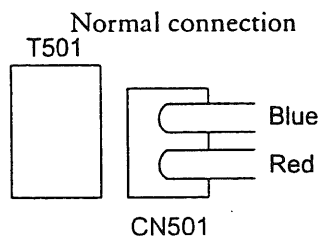

SECTION IV : ADJUSTMENTS

1. General Adjustment

Before starting general adjustment, the following tools are recommended to do below tuning :

- Digital voltage meter
- Frequency counter
- Degaussing Bar
- (■ Signal Generator)
- (■ Brightness meter (ft-L))

1.1 Signal Source (analog signals)

No.	Source	Mode	fH (kHz)	fV (Hz)	Clock (MHz)	Total	Sync	Video	BP	Sync polarity	Video level
1	Naomi (JAMMA31)	31k	31.69	59.80	27.00	31.55 μ S	3.04 μ S	23.70 μ S	3.22 μ S	Comp	0.7Vp-p
						530H	3H	480H	33H	Nega	75 Ω
2	Size limit 31k	31k	31.50	60.00	24.57	31.75 μ S	3.5 μ S	23.75 μ S	2.73 μ S	Comp	0.7Vp-p
						525H	3H	457H	43H	Nega	75 Ω

1.2 Adjustment Location

No.	PCB	Symbol	Name	Preset
1	MAIN	VR951	+B-ADJ	center
2	VR	VR283	Contrast	center
3	VR	VR285	H.SIZE	center
4	VR	VR286	H.POSI	center
5	VR	VR287	V.SIZE	center
6	VR	VR288	V.POSI	center
7	VR	VR284	Bright	center
8	VR	VR280	R.GAIN	center
9	VR	VR281	G.GAIN	center
10	VR	VR282	B.GAIN	center
11	MAIN	VR201	R.CUT OFF	counterclockwise max.
12	MAIN	VR202	G.CUT OFF	counterclockwise max.
13	MAIN	VR203	B.CUT OFF	counterclockwise max.
14	MAIN	VR550	H.HOLD	center
15	MAIN	VR204	SUB CONT	center
16	MAIN	VR205	ABL	center
17	MAIN	VR450	S.P.C	center
18	MAIN	VR452	TRAPEZOIDAL	center
19	MAIN	VR451	H.SIZE LIMIT	center
20	MAIN	VR402	V.SIZE LIMIT	center
21	MAIN	VR401	V.LIN	center
22	MAIN	VR552	PARA	center
23	MAIN	VR571	R.SHIFT	clockwise max.
24	MAIN	T502 (FBT)	SCREEN	counterclockwise max.
25	MAIN	T502 (FBT)	FOCUS	center

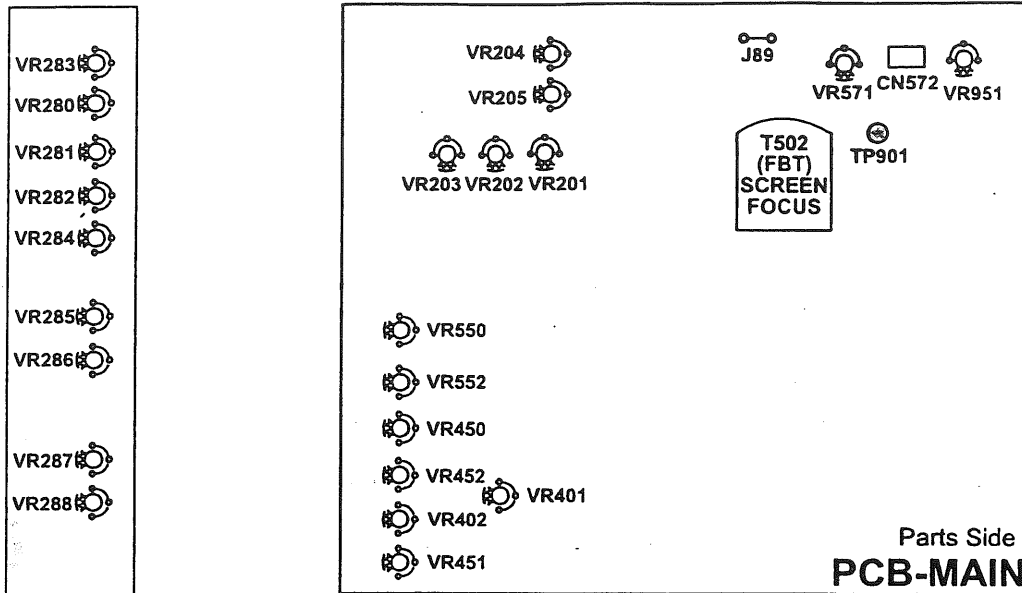

Adjustment Location for PCB-VR Adjustment Location for PCB-MAIN
(seen from parts side)

1.3 Before Adjustment

- Before starting any adjustment, read and observe all safety precautions shown earlier in "NOTICE".
- Make sure that all PCBs, chassis parts and connectors are in the right positions.
- Input voltage should be 100 VAC.
- Connect the GND terminal to the chassis base or the radiator at center of the PCB-MAIN.
- The CRT and the base should be degaussed.
- Make the pre-heat more than 30 minutes.
- The brightness in heat-running should be set 7 ft-L approx..
- The screen should face the east when adjusting, unless otherwise specified.
- The magnetic field should be set at the Japanese level (Bv: 0.35G, Bh: 0.3G)

WARNING

 **Do not short any position of the circuit while the monitor is in operation.**
This will cause smoke, electric shock or damage to transistors, ICs or other parts or circuit in the unit. (Excluding the adjustment only when specified).

◆ Input Connector

Video level	Video input connector
0.7 Vp-p / 75 Ω	CN251

1.4 Adjustments

1. +B Voltage Adjustment

	VR	How to adjust	Measure Point	Signal
1		Set the Digital voltage meter at the TP901.	TP901	None
2	VR951	Adjust 110 ± 0.2 VDC using the VR951.		

2. Preset

Turn the SCREEN VR slowly.

	VR	How to adjust	Signal
1	T502 (FBT) SCREEN VR	Receive the signal. Adjust the SCREEN VR on the FBT so that back-raster slightly appears.	No.1 Cross-hatch
2	FOCUS VR	Adjust the FOCUS VR on the FBT to get the best focused image.	

3. Degauss Circuit Confirmation

	VR	How to adjust	Signal
1	CN902	Receive the signal. Confirm that degaussing can be effective after magnetizing.	No.1 Red-field

4. Horizontal Sync Adjustment

	VR	How to adjust	Measure Point	Signal
1		Set the probe of the frequency counter at the DY Red lead.	DY Red Lead	None
2	VR550	Adjust the VR701 on the PCB-MAIN to get the free-run frequency 31.5 ± 0.2 kHz.		

5. Focus Adjustment

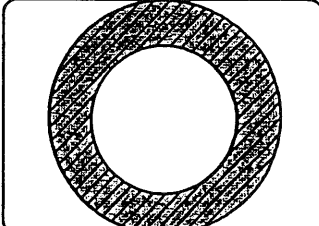
	VR	How to adjust	Signal
1	T502 (FBT) FOCUS VR	Receive the signal. Adjust with the FOCUS VR on the FBT to get the best focus in the below part. (See the below figure.) 	No.1

6. Color Purity Adjustment

	VR	How to adjust	Signal
1	DY	Receive the signal. Adjust by moving the DY back and forth to get the best purity. Keep the horizontal balance by opening the 2P magnet symmetrically.	No.1 Red-field
2	Magnet	Adjust the purity in the corners of the screen with the magnets.	
3		Confirm if the satisfactory purity is obtained in all four directions after degaussing.	

7. Convergence Adjustment

The anode of the Facet Style should face the west when adjusting, and the all directions when confirming.

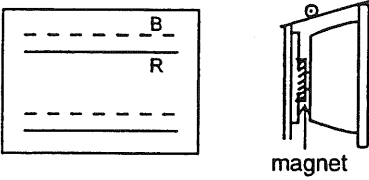
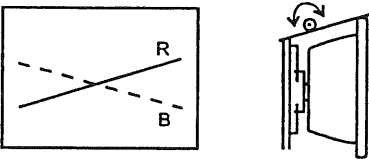
	VR	How to adjust	Signal
1	Magnet	Receive the signal. Adjust Yv with the magnet. (See the below figure.) 	No.1 Red-field
2	Differential coil	Adjust Yv with the differential coil. (See the below figure.) 	
3	Magnet	If the misconvergence still appears in the corners of the screen, put the ferrite magnet into the space between the CRT and the DY.	

8. H. Raster Shift Adjustment

VR571 is preset clockwise max.. In the reverse connection, adjust with the VRs in the opposite direction.

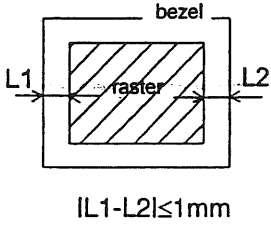
	VR	How to adjust	Signal
1	VR451	Receive the signal. Adjust the brightness so that the raster can appear slightly, and adjust the horizontal size to get the under-scanned image.	No.1 Black-field
2	VR571	Adjust the screen to set the horizontal raster position at the center of the bezel. When shifting the raster position to the left, insert the CN572 close to the CN571 (1pin). When shifting to the right, insert the CN572 close to the CN571 (3pin). (See the below figure.) 	
3		Twist the two harnesses of the CN572 together and set them out of the PCB so that they should not touch the FBT.	

9. H/V. Size Limit Adjustment

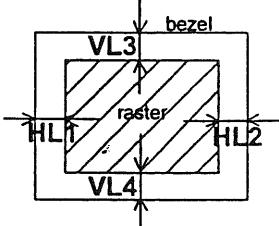
	VR	How to adjust	Signal
1	VR285 VR287	Receive the signal. Set the horizontal and vertical size at maximum.	No.2 Cross-hatch
2	VR402 VR451	Adjust the screen size to get the same size of the edge between the image and the CRT screen. (See the below figure.) 	

10. V. Linearity Adjustment

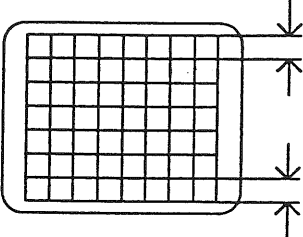
	VR	How to adjust	Signal
1	VR288	Receive the signal and set the image at the vertical center.	No.1
2	VR401	Adjust to get the desired linearity at the top and bottom of the crosshatch pattern. 	Cross-hatch

11. Distortion Adjustment

When adjusting the trapezoidal or/and parallelogram distortion, the CRT screen should face the east. As for the Facetop style, the anode should face the west.

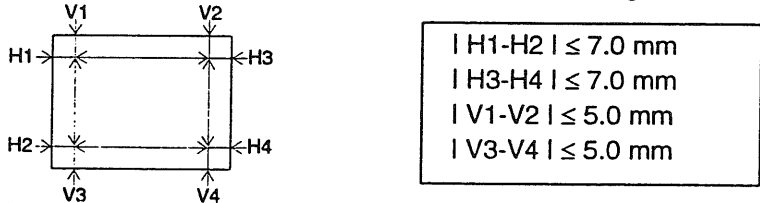
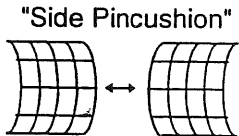
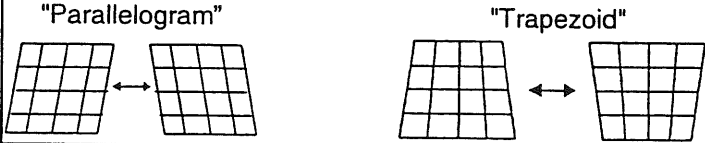
	VR	How to adjust	Signal
1		Receive the signal.	No.1
2		Confirm if the spec of the distortion meets the following value. 	Cross-hatch
3	VR450	Adjust the side pincushion distortion so that the vertical lines are straight from top to bottom. 	
4	VR452 VR552	Adjust the trapezoidal and parallelogramic distortion so that the length of the vertical lines are same from top to bottom. 	
5		If necessary, adjust the distortion, repeating steps 3 and 4.	

12. Size and Position Adjustment

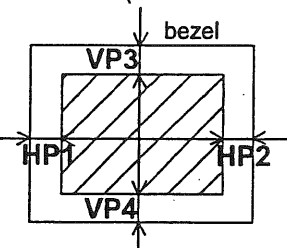
	VR	How to adjust	Signal
1		Receive the signal.	No.1
2	VR285 VR286 VR287 VR288	Adjust the size and position to get the same size of the edge between the image and the CRT screen. (See the below figure.)  HP1; HP2, VP3, VP4 = 10 ± 4 mm	Cross-hatch

13. Color Adjustment (White Balance and Brightness Adjustment)

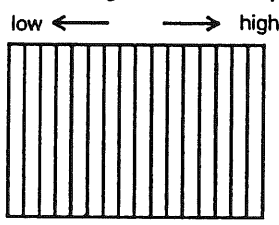
	VR	How to adjust	Signal
1		Receive the signal.	No.1
2	T502 (FBT) SCREEN VR	Set the brightness at maximum with the BRIGHT VR clockwise max. to get the brightness (0.8 ± 0.2 ft-L).	Black-field
3	VR201 VR202 VR203	Adjust R, G & B Cut Off to get a favorable white image. If a color analyzer is available, target color coordinates are as below. $x = 0.285 \pm 0.010$ $y = 0.285 \pm 0.010$	
4		If necessary, adjust the white balance repeating steps 2 and 3.	
5	VR284	Receive the grayscale signal. Adjust the brightness so that the raster, the first and the second gradation disappear.  16 grayscale pattern 1 st gradation part: 0/255, 2 nd gradation part: 12/255 Other parts: $17 \times (n-1)/255$ $n=1-16$	No.1 Grayscale
6	VR204	Receive the window signal. Adjust the window brightness (60.0 ± 2 ft-L).	No.1 33% Window
7	VR280 VR281 VR282	Adjust R, G & B Gain to get favorable white image. If a color analyzer is available, target color coordinates are as below. $x = 0.285 \pm 0.010$ $y = 0.285 \pm 0.010$	
8		If necessary, adjust the white balance repeating steps 6 and 7.	
9	VR205	Receive the white-field signal. Adjust the white-field brightness (32 ± 1 ft-L).	No.1 White-field

14. X-ray Protection Confirmation**Important Safety Work**

	VR	How to adjust	Measure Point	Signal
1		Input $13.2 \pm 0.1\text{VDC}$ to J89 with the DC power and make sure that the protector operation activates.	J89	No.1 Cross-hatch

15. Default Settings

	MS-2932-SF* (Facetop Style)	MS-2932-S* (TV Style)
CN501 (H.DY)	REVERSE	NORMAL
CN401 (V.DY)	NORMAL	NORMAL

SECTION V : TROUBLESHOOTING

1. No screen

1.1 Fuse (F901) blown

Trouble in the Primary circuit.

Check Q901, T901 BD901, D901, C905 and PTH901.

Recheck the input voltage when turning the power switch ON. (90~132 VAC)

1.2 High voltage comes up but no raster image

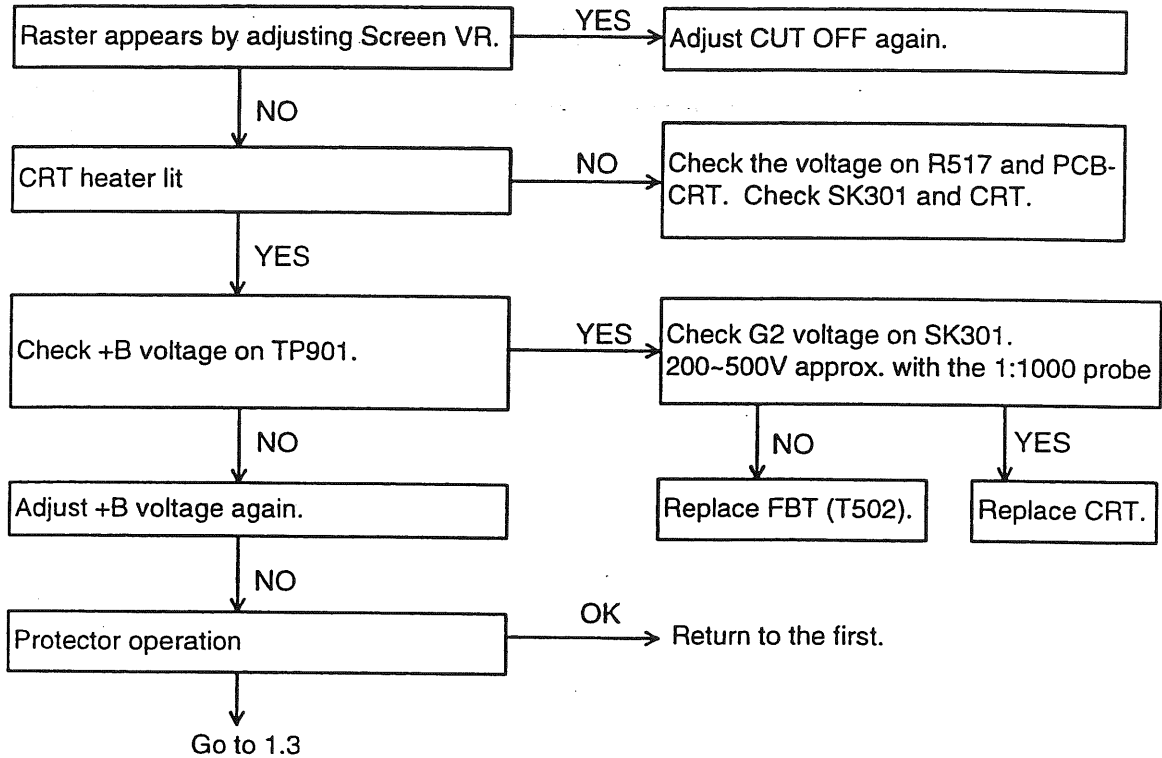

1.3 High voltage comes shortly

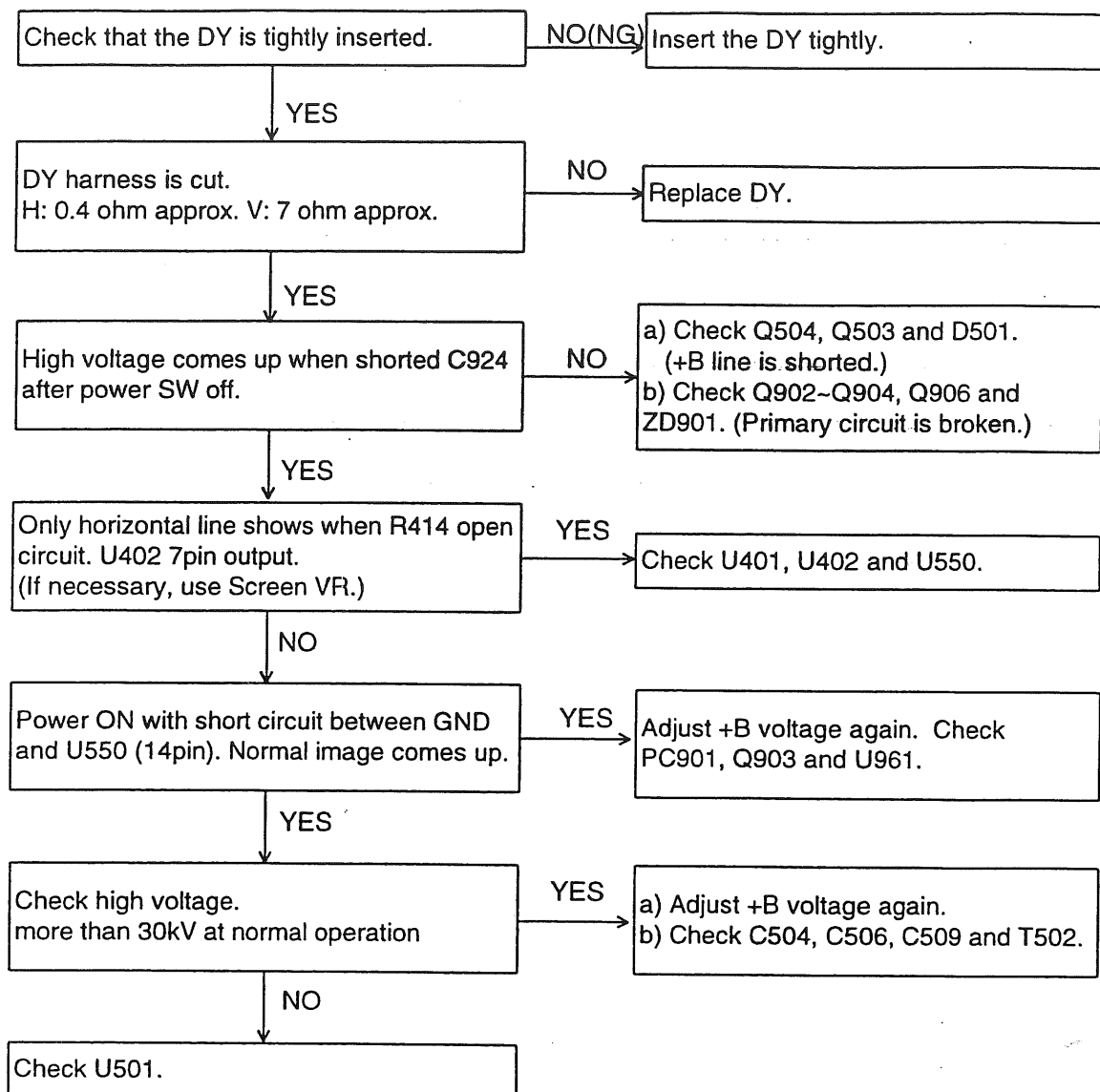

1.4 No high voltage but noise sounds

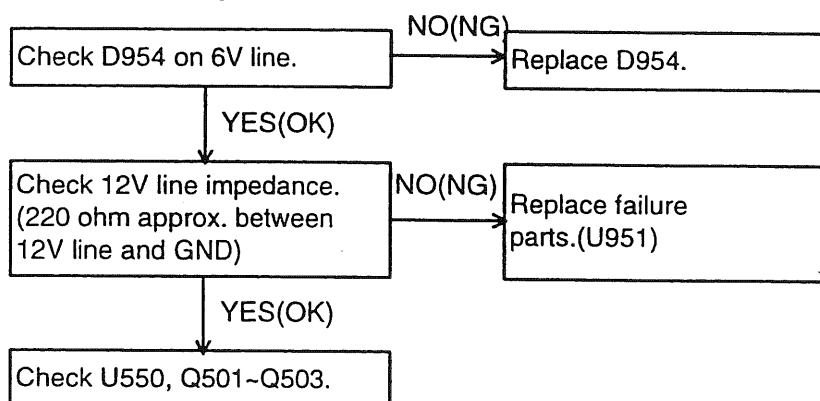

2. Raster appears but no image (or particular color is not displayed).

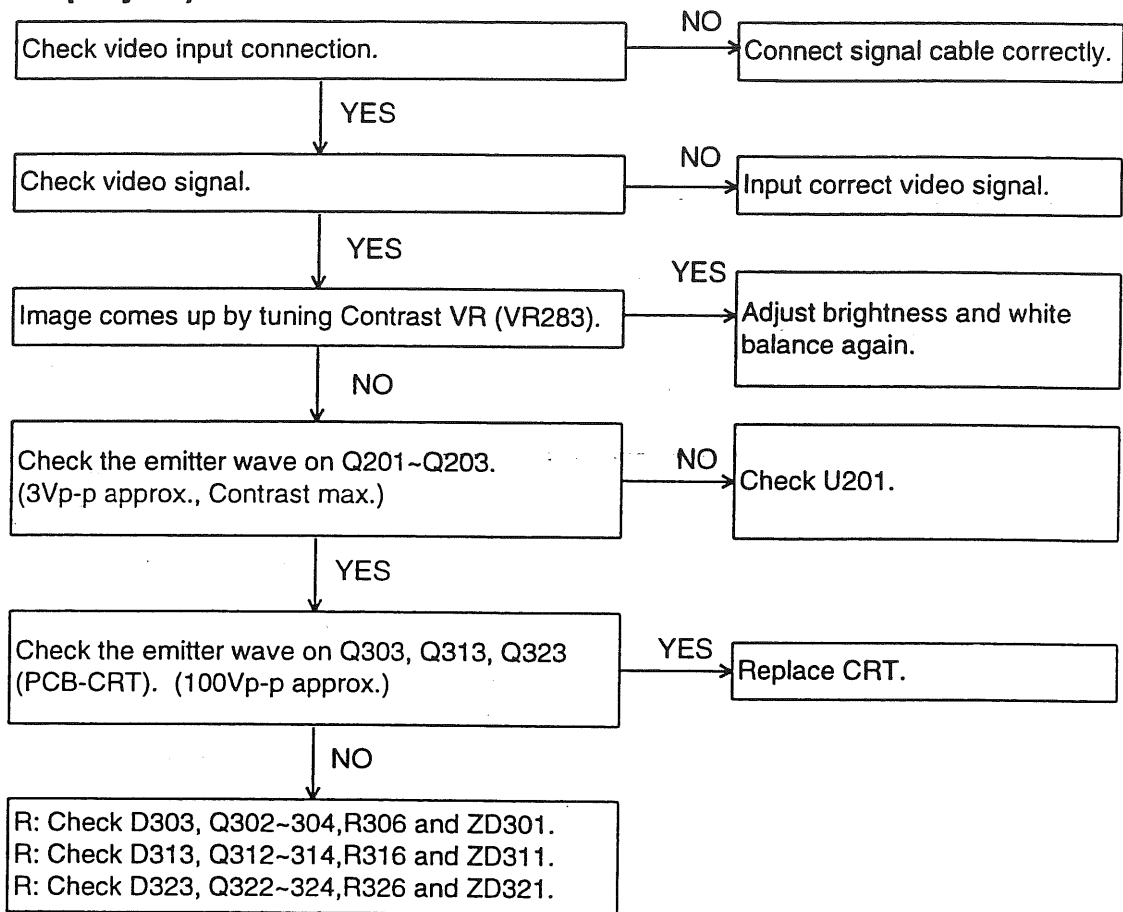

3. Sync is not correct.

3.1 Horizontal sync

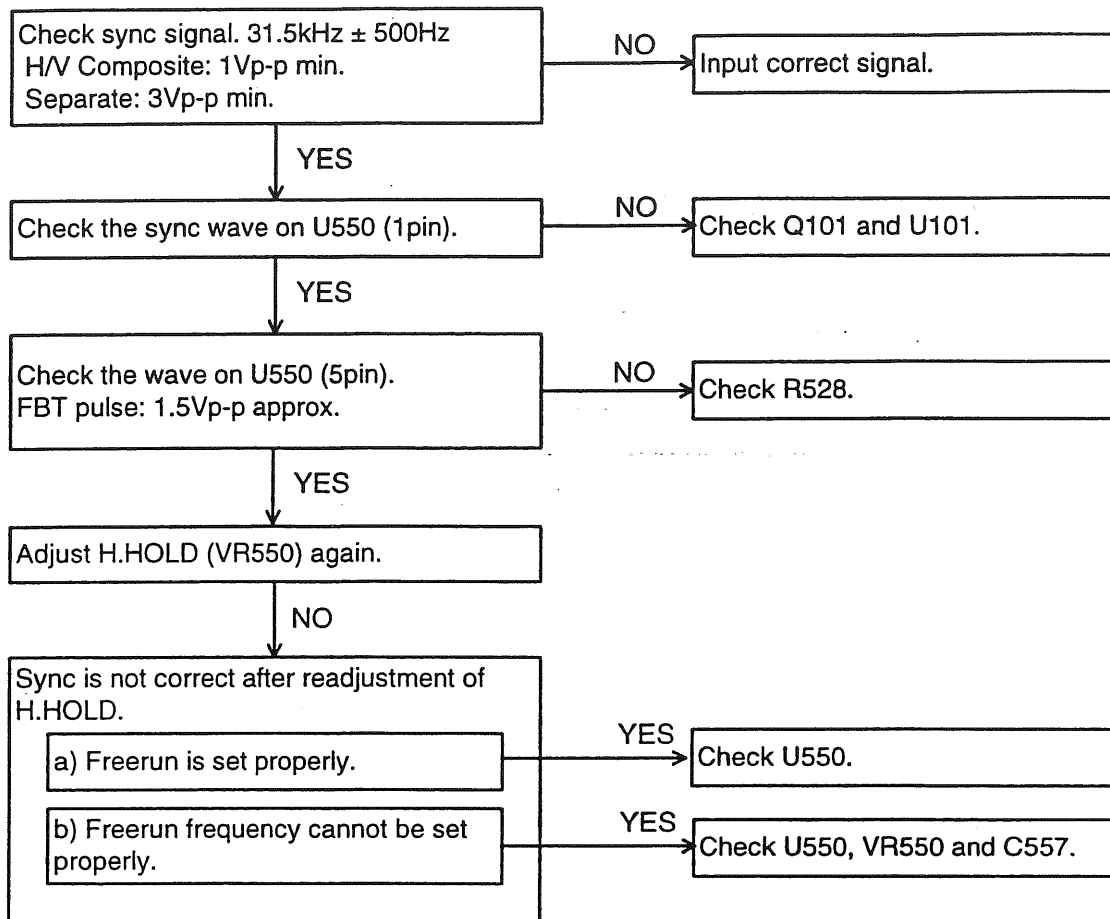

3.2 Vertical sync

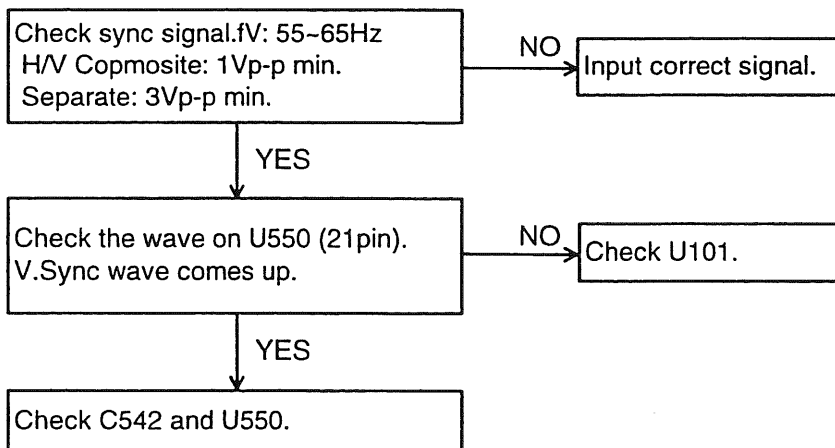

4. It is not possible to adjust the screen size

